



2010

KMG
C O M P A N Y

KMGcompany.com

Fabric Specific Extrusion

NLine's simplicity and beauty centers on its one of a kind extrusion system that frames the graphic on all four sides to assure a tight clean fit. This unique approach not only provides the best looking graphics, it also makes it easy to install and change the graphics.

Easy to Assemble & Lightweight

NLine's framing is constructed of durable, yet lightweight anodized aircraft grade aluminum extrusions that piece together quickly and easily. To assemble an entire 10' display, one person will simply need 30–40 minutes and the provided torx wrench*. For added convenience, NLine's T-Knob and F-Connector system provides simplicity when connecting or adjusting the position of shelves and accessories.

*Time based on a 10' foot display with canopy, lights, fabric wings and two tables. Some accessories may require additional tools.

Graphics

To achieve the best color and opacity, fabric graphics are produced on a heavy weight Engineered Fabric using our exclusive Photo Fabric® dye sublimation process. With our exclusive Expansion Strip, we provide graphics that install quickly and are taught and wrinkle-free. Header and wing graphics can be produced using the highest quality photographic prints and laminates.

Anatomy

Primary pieces of a NLine display include the main back wall, wings and a canopy. Build onto that by choosing from a multitude of shelving, headers or lighting accessories and you're ready to exhibit.

- **Back Wall**
Fabric graphics offer a quality look and feel to your message that traditional pop-up panels often fail to provide. The main graphic is produced on a wrinkle resistant, flame retardant fabric via an exclusive Photo Fabric® dye sublimation process. Moreover, NLine's tensioned fabric graphics provide a tighter, more clean-looking fit than any other system.
- **Wings**
NLine's unique wing system is the perfect complement to your display. Photo Fabric® or photographic wings enhance the look and provide additional area for graphics or branding.
- **Canopy**
Set your booth apart from traditional displays with NLine's unique canopy ceiling. This attractive arch not only lends a polished, professional touch to your message, it also provides an aesthetically pleasing background for lighting and header graphics.
- **Accessories Galore**
Mix and match accessories as you go. Choose from a variety of different shelving units, workstations, counters or lighting kits to accommodate your ever-changing trade show needs.
- **Packaging**
NLine offers you the versatility and convenience of multiple shipping cases. The Express case is compact and designed for UPS / FedEx shipments up to 150 lbs,* while the rolling Jumbo case can be used for 20' booths or booths using several accessories. For additional convenience and protection, the internal packaging foam is cut to fit the components.

example booth configurations

Configuration Example One



Qty.	Item	Description	Lbs.
1	5000	10' Flat Frame	44.30
1	1588	72" x 86" Flat Frame Graphic	4.20
1	5023	Inline Straight Wing Hardware Set	2.90
1	1079	Left Inline Wing Graphic	1.55
1	1080	Right Inline Wing Graphic	1.55
1	5030	Canopy Package	17.60
1	5035	V Table	10.80
1	5037	Literature Holder	2.50
2	5060	Stem Light	2.00
1	5050	Express Case (Not Pictured)	48.10

Total Lbs. 135.50

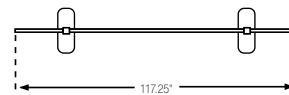

Configuration Example Two



Qty.	Item	Description	Lbs.
1	5000	10' Flat Frame	44.30
1	1588	72" x 86" Flat Frame Graphic	4.20
1	5021	Tapered Straight Wing Hardware Set	2.10
1	1077	Left Tapered Wing Graphic	1.55
1	1078	Right Tapered Wing Graphic	1.55
1	5030	Canopy Package	17.60
1	5062	Header Package	4.40
1	1936	Graphic For Header Package	0.50
2	5035	V Table	21.60
1	5061	Monitor Bracket*	1.60
2	5060	Stem Light	2.00
1	5050	Express Case (Not Pictured)	48.10

Total Lbs. 149.50

*Monitor not included

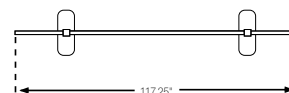

Configuration Example Three



Qty.	Item	Description	Lbs.
1	5001	10' Curved Frame	44.50
1	1589	74" x 86" Curved Frame Graphic	4.20
1	5025	Tapered Acrylic Wing Package	18.50
1	1934	Left Tapered Acrylic Wing Graphics	0.25
1	1935	Right Tapered Acrylic Wing Graphics	0.25
1	5030	Canopy Package	17.60
2	5035	V Table	21.60
2	5060	Stem Light	2.00
1	5050	Express Case (Not Pictured)	48.10

Total Lbs. 157.00**

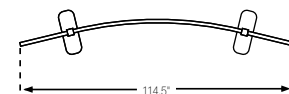

**Shipments that exceed 150lbs can not ship via UPS or FedEx small package service and are considered freight. A second case may be purchased to reduce the weight and allow for UPS or FedEx small package service.

Configuration Example Four



Qty.	Item	Description	Lbs.
1	5001	10' Curved Frame	44.50
1	1589	74" x 86" Curved Frame Graphic	4.20
1	5022	Tapered Curved Wing Hardware Set	2.10
1	1077	Left Tapered Wing Graphic	1.55
1	1078	Right Tapered Wing Graphic	1.55
1	5030	Canopy Package	17.60
1	5062	Header Package	4.40
1	1936	Graphic For Header Package	0.50
1	5035	V Table	10.80
3	5038	Kidney Shelf	14.70
2	5060	Stem Light	2.00
1	5050	Express Case (Not Pictured)	48.10
Total Lbs.			152.00**

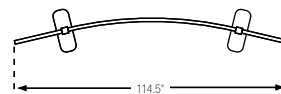

Configuration Example Five



Qty.	Item	Description	Lbs.
1	5000	10' Flat Frame	44.30
1	1592	72" x 86" Hidden Monitor Graphic	4.20
1	5025	Acrylic Wing Package	18.50
1	5030	Canopy Package	17.60
1	5062	Header Package	4.40
1	1936	Graphic For Header Package	0.50
1	5035	V Table	10.80
1	5039	Rectangle Shelf	4.90
1	5065	Hidden Monitor Hardware Package	3.30
1	5151	32" LCD Monitor*	29.40
2	5060	Stem Light	2.00
1	5050	Express Case (Not Pictured)	48.10
Total Lbs.			188.00**

*Monitor will ship in a separate package

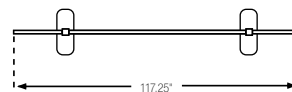

Configuration Example Six



Qty.	Item	Description	Lbs.
1	5002	20' Flat Frame- Convertible 1	91.60
1	1588	72" x 86" Flat Frame Graphic	4.20
2	1590	56" x 86" Flat Frame Graphic	5.00
1	5025	Tapered Acrylic Wing Package	18.50
1	1934	Left Tapered Acrylic Wing Graphics	0.25
1	1935	Right Tapered Acrylic Wing Graphics	0.25
1	5030	Canopy Package	17.60
2	5038	Kidney Shelf	9.80
2	5061	Monitor Bracket*	3.20
2	5060	Stem Light	2.00
1	5051	Jumbo Case (Not Pictured)	234.00
Total Lbs.			386.40

*Monitors not included



**Shipments that exceed 150lbs can not ship via UPS or FedEx small package service and are considered freight. A second case may be purchased to reduce the weight and allow for UPS or FedEx small package service.

example booth configurations

Configuration Example Seven



Qty.	Item	Description	Lbs.
1	5004	20' Curved Frame- Convertible 1	91.56
1	1589	74" x 86" Flat Curved Graphic	4.20
2	1590	56" x 86" Flat Frame Graphic	6.40
1	5022	Tapered Curved Wing Hardware Set	2.10
1	1077	Left Tapered Wing Graphic	1.55
1	1078	Right Tapered Wing Graphic	1.55
1	5030	Canopy Package	17.60
1	5062	Header Package	4.40
1	1936	Graphic For Header Package	0.50
2	5039	Rectangle Shelf	9.80
2	5068	Rear Projection Package*	10.00
2	5060	Stem Light	2.00
1	5051	Jumbo Case (Not Pictured)	234.00

Total Lbs. 385.66

*Projectors not included

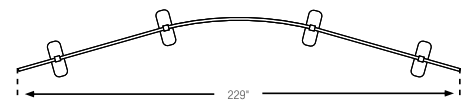

Configuration Example Eight



Qty.	Item	Description	Lbs.
1	5005	20' Curved Frame- Convertible 2	91.70
1	1590	56" x 86" Flat Frame Graphic	3.20
2	1589	74" x 86" Curved Frame Graphic	8.40
1	5024	Inline Curved Wing Hardware Set	2.90
1	1079	Left Inline Wing Graphic	1.55
1	1080	Right Inline Wing Graphic	1.55
2	5030	Canopy Package	35.20
2	5035	V Table	21.60
6	5039	Rectangle Shelf	29.40
4	5060	Stem Light	4.00
1	5051	Jumbo Case (Not Pictured)	234.00

Total Lbs. 433.50

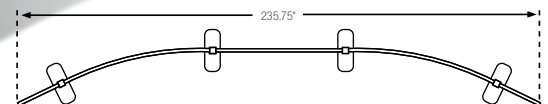

Configuration Example Nine



Qty.	Item	Description	Lbs.
1	5003	20' Flat Frame- Convertible 2	91.60
1	1594	40" x 86" Hidden Monitor Graphic	2.60
2	1588	72" x 86" Flat Frame Graphic	8.40
1	5025	Tapered Acrylic Wing Package	18.50
1	1934	Left Tapered Acrylic Wing Graphics	0.25
1	1935	Right Tapered Acrylic Wing Graphics	0.25
2	5030	Canopy Package	35.20
2	5062	Header Package	8.80
2	1936	Graphic For Header Package	1.00
2	5035	V Table	21.60
1	5151	32" LCD Monitor*	29.40
1	5067	Hidden Monitor Hardware Package 3	1.90
4	5060	Stem Light	4.00
1	5051	Jumbo Case (Not Pictured)	234.00

Total Lbs. 457.50

*Monitor will ship in a separate package



Item #5000

10' Flat Frame

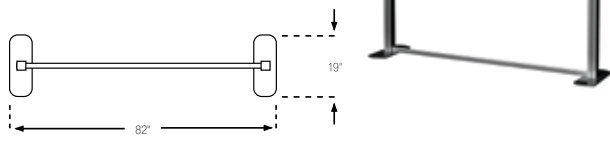

Dimensions: 82" w x 86" h x 19" d
Weight: 44.3 Lbs.
Construction: 2.75" Extruded Aluminum Supports, 1.5" Extruded Aluminum Rails
 And .375" Thick Aluminum Feet
Graphic: Item #1588



Item #1588

**72" x 86" Flat
Frame Graphic**

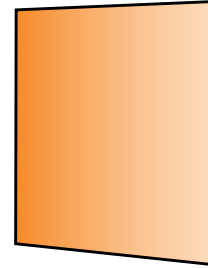

Graphic Dimensions: Refer To Template
Weight: 4.2 Lbs.
Construction: FR Photo Fabric® Graphic With Expansion Strip

Item #5001

10' Curved Frame

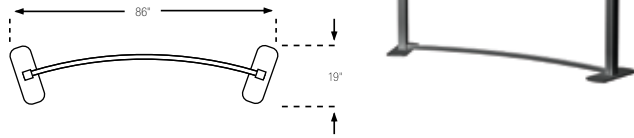

Dimensions: 82" w x 86" h x 19" d
Weight: 44.5 Lbs.
Construction: 2.75" Extruded Aluminum Supports, 1.5" Extruded Aluminum Rails
 And .375" Thick Aluminum Feet
Graphic: Item #1589



Item #1589

**74" x 86" Curved
Frame Graphic**

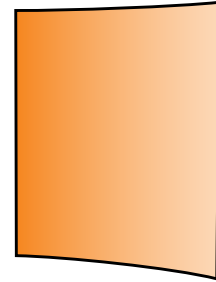

Graphic Dimensions: Refer To Template
Weight: 4.2 Lbs.
Construction: FR Photo Fabric® Graphic With Expansion Strip

Item #5002

**20' Flat Frame-
Convertible 1**

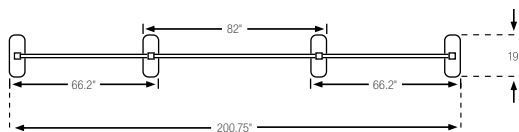

Dimensions: 200.75" w x 86" h x 19" d
Weight: 91.6 Lbs.
Construction: 2.75" Extruded Aluminum Supports, 1.5" Extruded Aluminum Rails
 And .375" Thick Aluminum Feet
Graphics: Item #1588 (Qty. 1), Item #1590 (Qty. 2)
Note: Large Display Converts Into One 10' Display

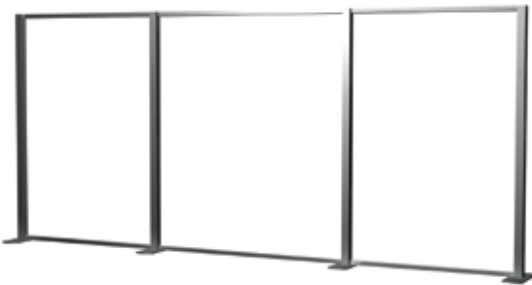

Item #1588

**72" x 86" Flat
Frame Graphic**

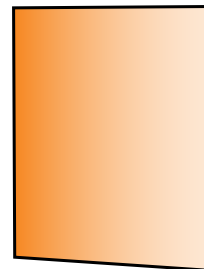

Center Graphic- 1 Required

Item #1590

**56" x 86" Flat
Frame Graphic**

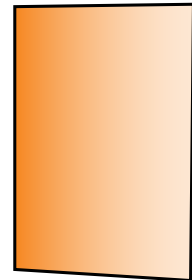

Left and Right Graphic- 2 Required

Graphic Dimensions: Refer To Template
Weight: 9.2 Lbs.
Construction: FR Photo Fabric® Graphic With Expansion Strip

Item #5003

20' Flat Frame-
Convertible 2

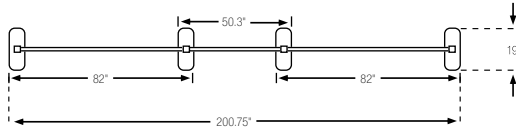
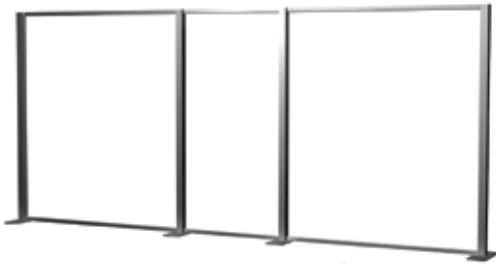

Dimensions: 200.75" w x 86" h x 19" d

Weight: 91.6 Lbs.

Construction: 2.75" Extruded Aluminum Supports, 1.5" Extruded Aluminum Rails
And .375" Thick Aluminum Feet

Graphics: Item #1591 (Qty. 1), Item #1588 (Qty. 2)

Note: Large Display Converts Into Two 10' Displays. May Require Additional Case Or Accessories

Item #1591

40" x 86" Flat
Frame Graphic



Center Graphic- 1 Required

Item #1588

72" x 86" Flat
Frame Graphic

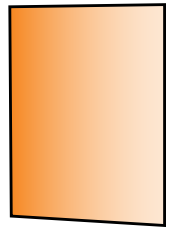

Left and Right Graphic- 2 Required

Graphic Dimensions: Refer To Template

Weight: 10.9 Lbs.

Construction: FR Photo Fabric® Graphic With Expansion Strip

Item #5004

20' Curved Frame-
Convertible 1

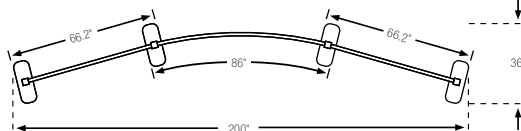
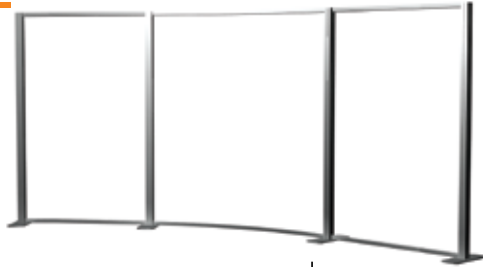

Dimensions: 200" w x 86" h x 36" d

Weight: 91.56 Lbs.

Construction: 2.75" Extruded Aluminum Supports, 1.5" Extruded Aluminum Rails
And .375" Thick Aluminum Feet

Graphics: Item #1589 (Qty. 1), Item #1590 (Qty. 2)

Note: Large Display Converts Into One 10' Display

Item #1589

74" x 86" Curved
Frame Graphic

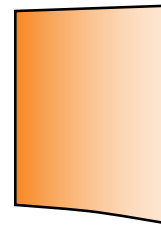

Left and Right Graphic- 1 Required

Item #1590

56" x 86" Flat
Frame Graphic

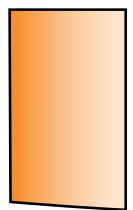

Center Graphic- 2 Required

Graphic Dimensions: Refer To Template

Weight: 10.6 Lbs.

Construction: FR Photo Fabric® Graphic With Expansion Strip

Item #5005

20' Curved Frame-
Convertible 2

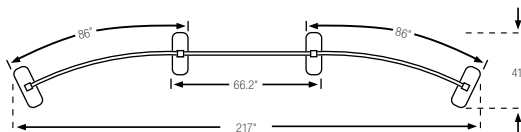
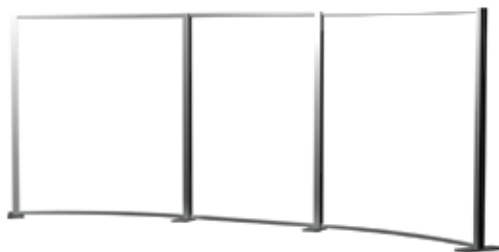

Dimensions: 217" w x 86" h x 41" d

Weight: 91.7 Lbs.

Construction: 2.75" Extruded Aluminum Supports, 1.5" Extruded Aluminum Rails
And .375" Thick Aluminum Feet

Graphics: Item #1590 (Qty. 1), Item #1589 (Qty. 2)

Note: Large Display Converts Into Two 10' Displays. May Require Additional Case Or Accessories

Item #1590

56" x 86" Flat
Frame Graphic

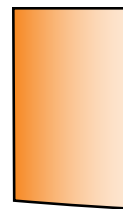

Center Graphic- 1 Required

Item #1589

74" x 86" Curved
Frame Graphic

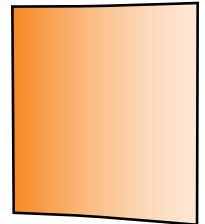

Left And Right Graphic- 2 Required

Graphic Dimensions: Refer To Template

Weight: 11.6 Lbs.

Construction: FR Photo Fabric® Graphic With Expansion Strip

Item #5021

Tapered Straight Wing Hardware Set

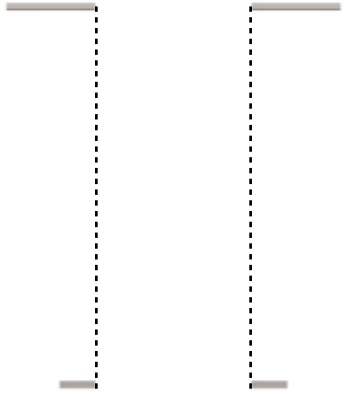
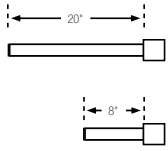

Vertical Supports Are Part Of Frame Hardware

Dimensions: 20"w x 1.5"h (1 Qty. Left, 1 Qty. Right)
8"w x 1.5"h (1 Qty. Left, 1 Qty. Right)
Weight: 2.1 Lbs.
Construction: 1.5" Extruded Aluminum
Graphics: Item #1077 (Qty. 1), Item #1078 (Qty. 1)

Item #1077

Left Tapered Wing Graphic



1 Required

Item #1078

Right Tapered Wing Graphic

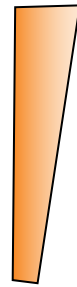

1 Required

Graphic Dimensions: Refer To Template
Weight: 3.1 Lbs.
Construction: FR Photo Fabric® Graphic With Expansion Strip

Item #5022

Tapered Curved Wing Hardware Set

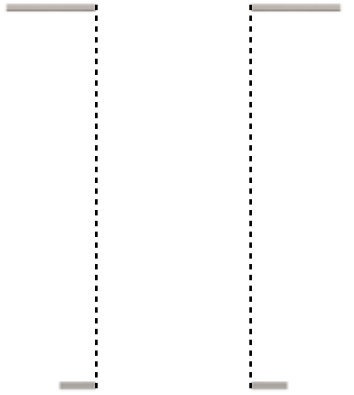
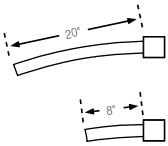

Vertical Supports Are Part Of Frame Hardware

Dimensions: 20"w x 1.5"h (1 Qty. Left, 1 Qty. Right)
8"w x 1.5"h (1 Qty. Left, 1 Qty. Right)
Weight: 2.1 Lbs.
Construction: 1.5" Extruded Aluminum
Graphics: Item #1077 (Qty. 1), Item #1078 (Qty. 1)

Item #1077

Left Tapered Wing Graphic



1 Required

Item #1078

Right Tapered Wing Graphic

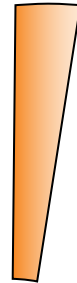

1 Required

Graphic Dimensions: Refer To Template
Weight: 3.1 Lbs.
Construction: FR Photo Fabric® Graphic With Expansion Strip

Item #5023

Inline Straight Wing Hardware Set

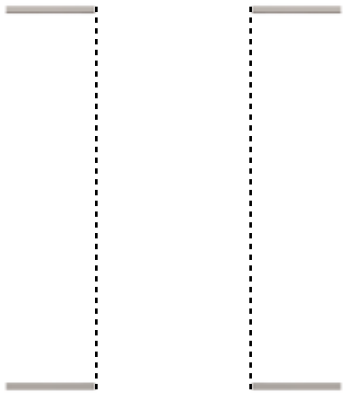
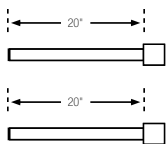

Vertical Supports Are Part Of Frame Hardware

Dimensions: 20"w x 1.5"h (2 Qty. Left, 2 Qty. Right)
Weight: 2.9 Lbs.
Construction: 1.5" Extruded Aluminum
Graphics: Item #1079 (Qty. 1), Item #1080 (Qty. 1)

Item #1079

Left Inline Wing Graphic



1 Required

Item #1080

Right Inline Wing Graphic

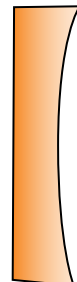

1 Required

Graphic Dimensions: Refer To Template
Weight: 3.1 Lbs.
Construction: FR Photo Fabric® Graphic With Expansion Strip

Item #5024

Inline Curved Wing Hardware Set

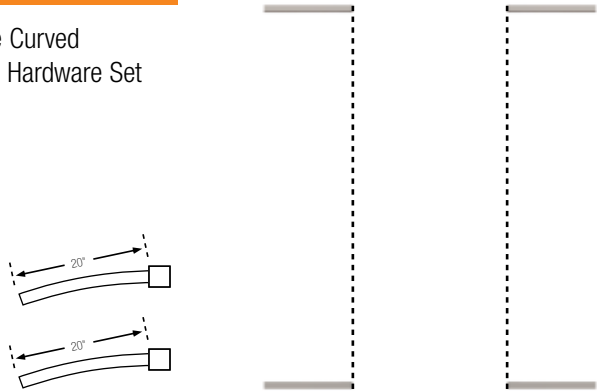

Vertical Supports Are Part Of Frame Hardware.

Dimensions: 20"w x 1.5"h (2 Qty. Left, 2 Qty. Right)
Weight: 2.9 Lbs.
Construction: 1.5" Extruded Aluminum
Graphics: Item #1079 (Qty. 1), Item #1080 (Qty. 1)

Item #1079

Left Inline Wing Graphic



1 Required

Graphic Dimensions: Refer To Template
Weight: 3.1 Lbs.
Construction: FR Photo Fabric® Graphic With Expansion Strip

Item #1080

Right Inline Wing Graphic

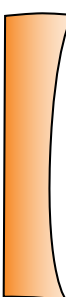

1 Required

Item #5025

Tapered Acrylic Wing Package

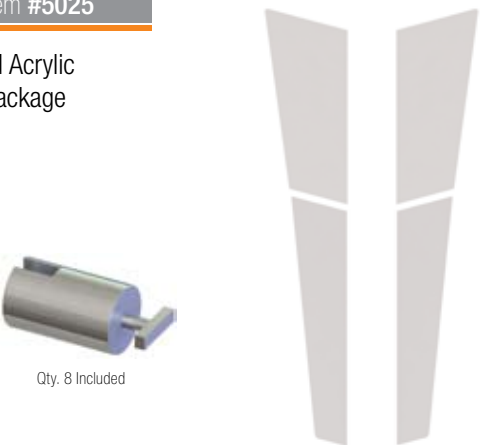

Qty. 8 Included

Dimensions: Top Wing: 42.75"h x 19.5"w / 13.75"w (Top Left- Qty. 1, Top Right- Qty. 1)
 Bottom Wing: 42.75"h x 13.75"w / 8"w (Bottom Left- Qty. 1, Bottom Right- Qty. 1)
Weight: 18.5 Lbs.
Construction: 5mm Frosted Acrylic
Graphics: Item #1934 (Qty. 1), Item #1080 (Qty. 1)

Item #1934

Left Tapered Acrylic Wing Graphics



Graphic Dimensions: Refer To Template
Weight: .5 Lbs.
Construction: Lambda Flex With Textured, Gloss Or Matte Laminate Mounted To Frosted Acrylic

Item #1935

Right Tapered Acrylic Wing Graphics

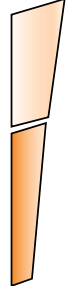

Item #5030

Canopy Package



Dimensions: 95"w x 13"h*
Weight: 17.6 Lbs.
Construction: 1.75" Aluminum Posts, 1.5" Aluminum Support Rail And Laminated Metal Canopy

*Height Is From Top Of Frame To Top Of Canopy. Raising Or Lowering The Collar On The Risers Will Adjust Canopy Height.

Item #5060

Stem Light



Dimensions: 12"l Arm With 2"d Bulb
Weight: 1.0 Lbs.
Construction: Metal Arm With T-Knob And 50 Watt Halogen Lamp

Item #5062

Header Package



Dimensions: 64.5"w x 8.5"h
Weight: 4.4 Lbs.
Construction: 5mm Frosted Acrylic
Graphic: Item #1936

⚠ - Header Package Requires Canopy Package (#5030)

Item #1936

Graphic for Header Package

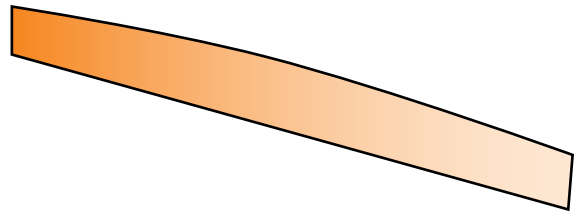

Graphic Dimensions: Refer To Template
Weight: .5 Lbs.
Construction: Lambda Flex With Textured, Gloss Or Matte Laminate Mounted To Frosted Acrylic

Item #5035

V Table



Dimensions: 25.5"w x 42"h x 16.5"d
Weight: 10.8 Lbs.
Load Weight: 75 Lbs.
Construction: 5mm Frosted Acrylic Top With F Clamp and 1.25" Aluminum Supports

Item #5036

24"d Table



Dimensions: 24"d x 29.75"h
Weight: 10.8 Lbs.
Load Weight: 75 Lbs.
Construction: 5mm Frosted Acrylic Top And Base With 2.75" Aluminum Support

Item #5037

Literature Holder



Dimensions: 11" dia. Shelf With 8"h Tallest Divider
Weight: 2.5 Lbs.
Load Weight: 25 Lbs.
Construction: 5mm Frosted Acrylic With F Clamp And Aluminum Dividers

Item #5038

Kidney Shelf



Dimensions: 20.25"w x 10.25"d
Weight: 4.9 Lbs.
Load Weight: 25 Lbs.
Construction: 5mm Frosted Acrylic With Aluminum F Clamp

Item #5039

Rectangle Shelf

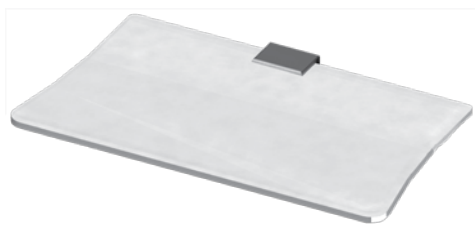

Dimensions: 25.4"w x 14"d
Weight: 4.9 Lbs.
Load Weight: 25 Lbs.
Construction: 5mm Frosted Acrylic With Aluminum F Clamp

Items #3686, #3687, #3688

Pop-up Podium

Black Table Top (#3686)

White Table Top (#3687)

Wood Grain Table Top (#3688)

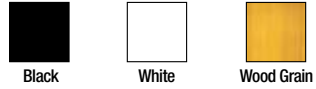

Podium Dimensions: 41.75"l x 15.75"w x 38.5"h

Podium Weight: 25 Lbs.

Podium Load Weight: 25 Lbs. Evenly Distributed

Storage Shelf Load Weight: 7 Lbs. Evenly Distributed

Construction: Collapsible Aluminum Frame With Sure Lock Connectors
And Velcro Perimeter; Corrugated Plastic Storage Shelf

Packaging: Frame, Shelf And Attached Graphic Come In Durable Nylon Carrying Bag
And Will Only Fit In A Jumbo Case

Item #1585

Graphic For
Pop-up Podium

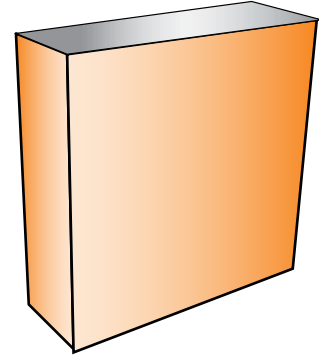

Graphic Dimensions: Refer To Template

Graphic Weight: 1 Lbs.

Construction: FR Photo Fabric® Graphic With Velcro Perimeter - Open Back

Rear Projection

Designed to be used with any projector that has at least a 1:1.75 aspect/throw ratio, the 3mm rear projection acrylic provides excellent color vibrancy and allows the image to completely bleed on all sides.

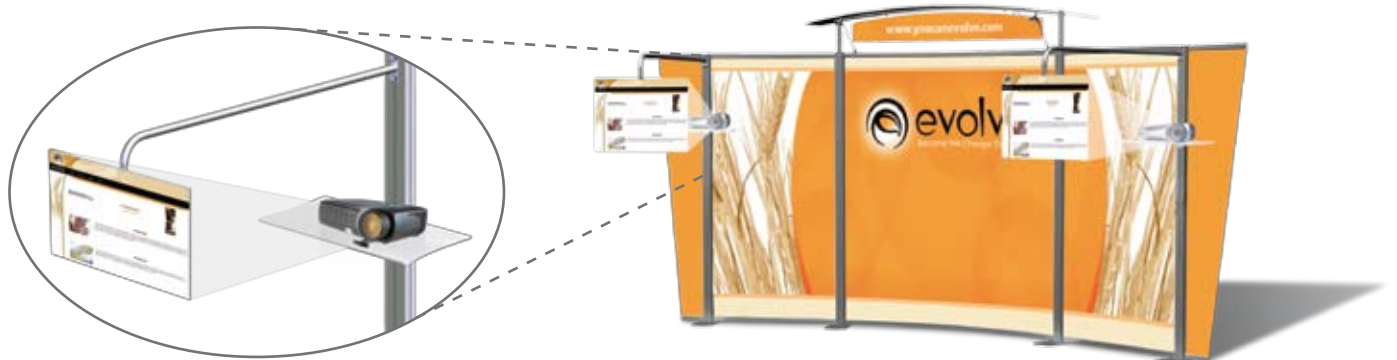

Hidden Monitor

NLine's hidden monitor is uniquely designed with a graphic channel that allows the fabric to frame the entire monitor.

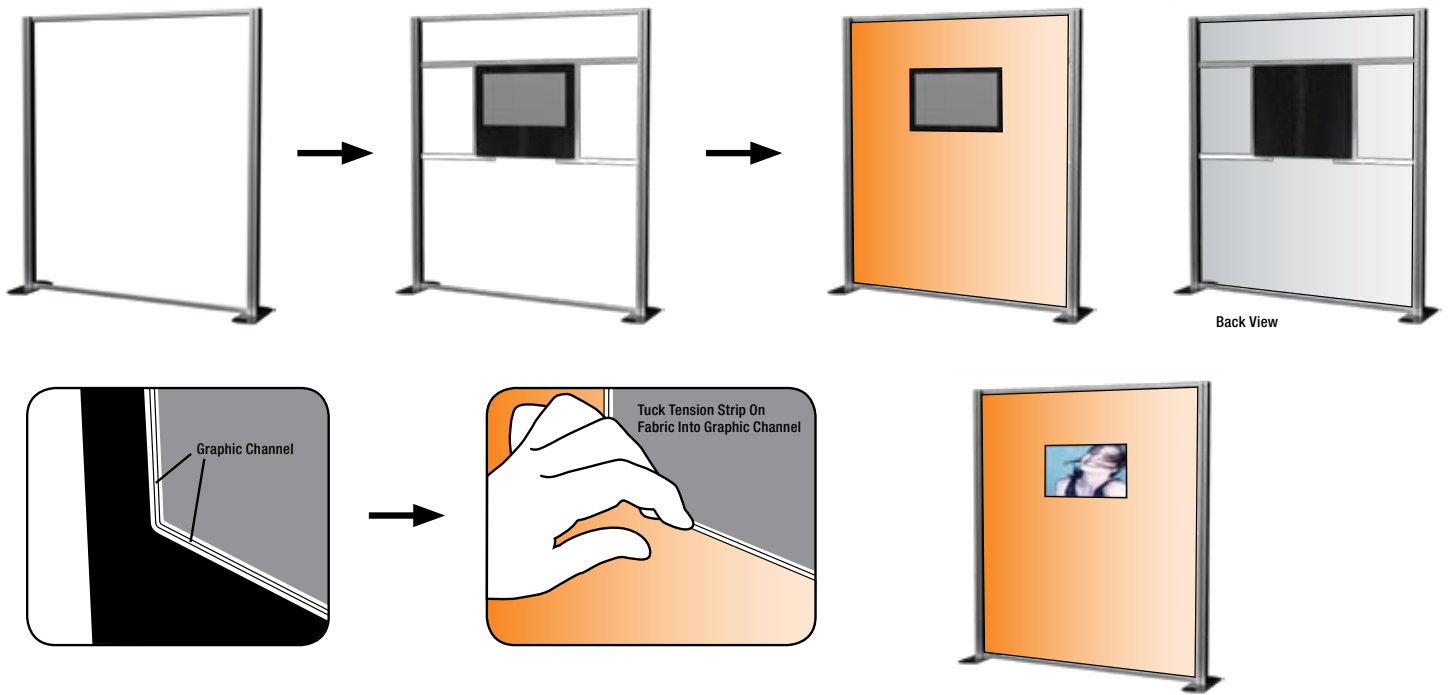

A variety of A/V connections allow the monitor to be used with many input devices.

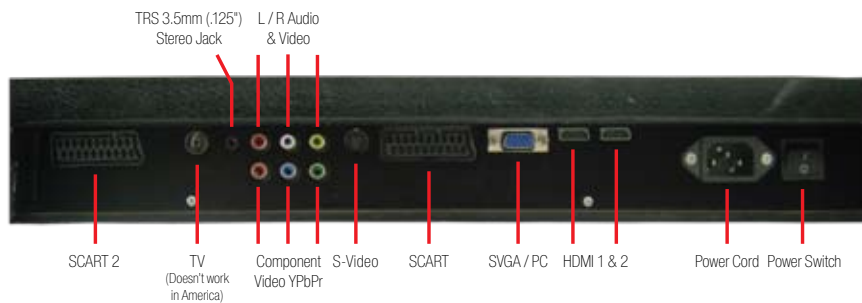

Item #5068

27.5" X 20.625" Rear
Projection Package

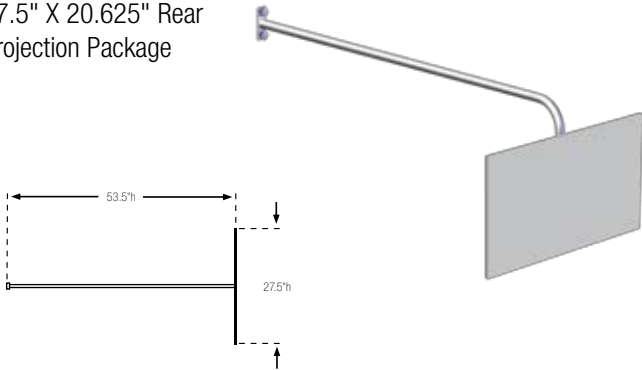

Screen Dimensions: 27.5"w x 20.625"h x 53.5"l (1:1.75 Aspect/Throw Ratio)
Weight: 5 Lbs.
Construction: 3mm Rear Projection Acrylic With 1" Aluminum Arm

Item #5061

Monitor Bracket



Weight: 1.6 Lbs.
Construction: Aluminum VESA 75 x 75 Or 100 x 100 Bracket

Item #5064

Cable Management

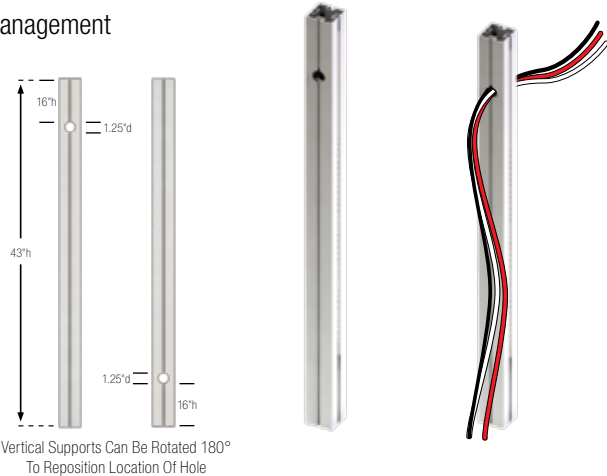

Dimensions: 1.25" Hole Drilled Through Vertical Support To Allow Cables To Pass From Front To Back Of Display

Item #5151

32" HD Monitor

Weight: 29.4 Lbs.
Specifications:

- Remote Control (Monitor Can Be Controlled Via Remote Or By Controls Located On The Monitor)
- Samsung LCD Panel
- Resolution: Wide XGA
- Aspect Ratio: 16:9
- Max Resolution: 1,366 x 768 @60 Hz
- Contrast Ratio: 1200:1
- Brightness (cd m2): 500
- Response Time: 8 ms.
- Viewing Angle: 90/90/90/90
- Inputs: Supported Signals: 480P/576P/720P/1080i, HDMI (Qty. 2), SVGA / PC, TRS 3.5mm (.125") Stereo Jack, L / R Audio & Video, Component Video (YPbPr)(Qty. 2), SCART (Qty. 2), S-Video

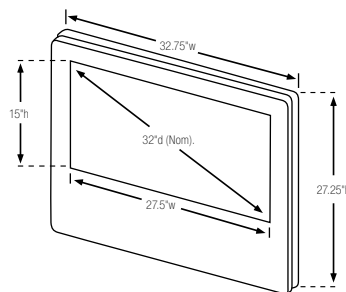

Requires Monitor Package

- ⚠ - Monitor Cannot Be Used With Monitor Bracket (Item #5061)
- Monitor Will Not Fit In Express Or Jumbo Case

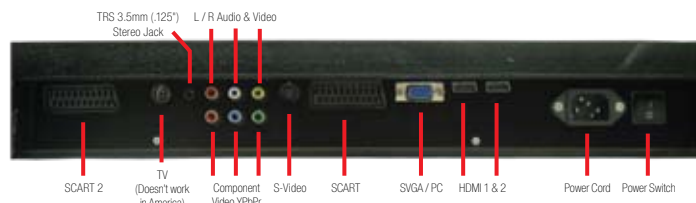

Item #5065

Hidden Monitor
Hardware Package 1

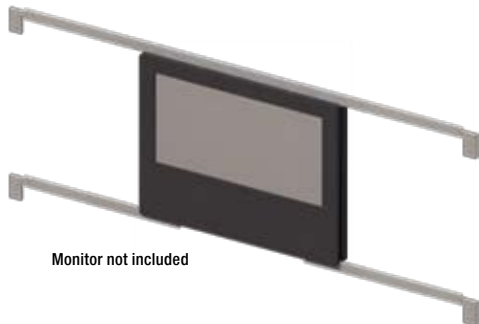

Monitor not included

Dimensions: Top Rail 72.5" / Bottom Rails 25.8"
Weight: 3.3 Lbs.
Construction: 1.5" Extruded Aluminum
Used With: Item #5000, #5002 - Center Or #5003 - Ends
⚠ Can Only Be Used With Flat Frame Hardware

Item #1592

72" x 86" Hidden
Monitor Graphic

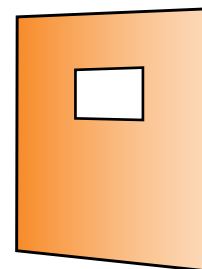

Graphic Dimensions: Refer To Template
Weight: 4.2 Lbs.
Construction: FR Photo Fabric[®] Graphic With Expansion And Tension Strip
Note: Replaces Graphic Item #1588

Item #5066

Hidden Monitor
Hardware Package 2

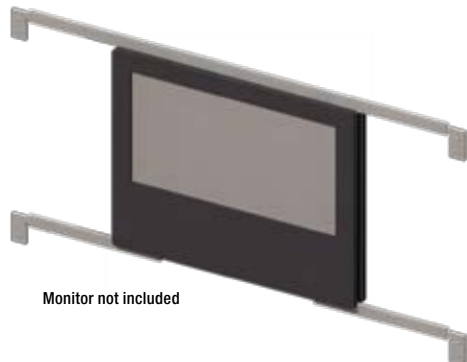

Monitor not included

Dimensions: Top Rail 56.6875" / Bottom Rails 18.06"
Weight: 2.6 Lbs.
Construction: 1.5" Extruded Aluminum
Used With: Item #5002 - Ends, #5004 - Ends Or #5005 - Center
⚠ Can Only Be Used With Flat Frame Hardware

Item #1593

56" x 86" Hidden
Monitor Graphic

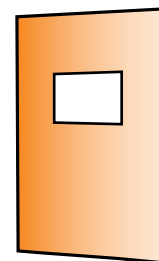

Graphic Dimensions: Refer To Template
Weight: 3.2 Lbs.
Construction: FR Photo Fabric[®] Graphic With Expansion And Tension Strip
Note: Replaces Graphic Item #1590

Item #5067

Hidden Monitor
Hardware Package 3

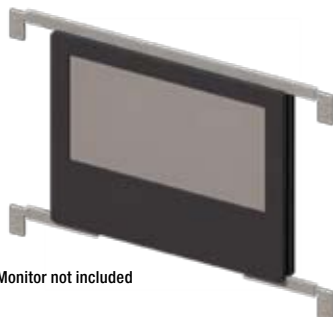

Monitor not included

Dimensions: Top Rail 40.8125" / Bottom Rails 10.03"
Weight: 1.9 Lbs.
Construction: 1.5" Extruded Aluminum
Used With: Item #5003 - Center
⚠ Can Only Be Used With Flat Frame Hardware

Item #1594

40" x 86" Hidden
Monitor Graphic

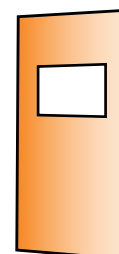

Graphic Dimensions: Refer To Template
Weight: 2.6 Lbs.
Construction: FR Photo Fabric[®] Graphic With Expansion And Tension Strip
Note: Replaces Graphic Item #1591

Item #5050

Express Case



Dimensions: 72"l x 26"w x 10"h (ID)
74"l x 28"w x 11"h (OD)

Weight: 48.1 Lbs.

Construction: Vacuum Formed High Density Polyethylene With Wheels
And High Density Foam Cut To Fit Case And Components

Note: - All frames require a shipping case
- Shipments that exceed 150lbs can not ship via UPS or FedEx small package service and are considered freight. A second case may be purchased to reduce the weight and allow for UPS or FedEx small package service.
- Some Accessories Will Be Individually Wrapped In Foam Or Plastic
- Same Foam Is Used In Both Cases And Will Be Cut To Appropriate Size For Case(s) Being Ordered

Item #5051

Jumbo Case













Dimensions: 87"l x 25"w x 18.5"h (ID)
90"l x 28"w x 31"h (OD)

Weight: 234 Lbs.

Construction: Wood With Metal Corners, Lockable Lid, Casters, Foam Lining,
And High Density Foam Cut To Fit Case And Components

Note: - All frames require a shipping case
- Some Accessories Will Be Individually Wrapped In Foam Or Plastic
- Same Foam Is Used In Both Cases And Will Be Cut To Appropriate Size For Case(s) Being Ordered

	Item #	Description
	#5100	Extrusion Lock
	#5101	T- Knob
	#5102	Threaded Knob
	#5105	Through Hole Threaded Knob
	#5120	Wing End Cap
	#5148	Bulb For Stem Light
	#5147	Torx Wrench
	#5155	Allen Wrench Set (1.5, 2, 2.5, 3, 4, 5, 6mm)
 	#5153	Traveling Sample Kit- <ul style="list-style-type: none"> - 1 Qty: 15.75"w x 15.75"h Frame With 2.75" Extruded Aluminum Supports, 1.5" Extruded Aluminum Rails And 4"d x .375" Thick Aluminum Feet - 1 Qty: Fabric Graphic - 1 Qty: 3.25"w x 18.5"l Canopy Sample (Does Not Connect To Frame) - 2 Qty: 3.75"w x 15.75"h 5mm Tapered Frost Acrylic Wing - 4 Qty: Wing Clamps - 1 Qty: 1.5"w x 4"l Extruded Aluminium Wing Bar - 1 Qty: 12"l Stem Light, Bulb & Transformer - 1 Qty: Torx Wrench - 1 Qty: F Clamp

Contact us for availability of additional replacement elements.



2009

tradeshow booths

display hardware

banners

graphics

KMG
C O M P A N Y

KMGcompany.com